

STORA-DRAIN

SELF-type SB

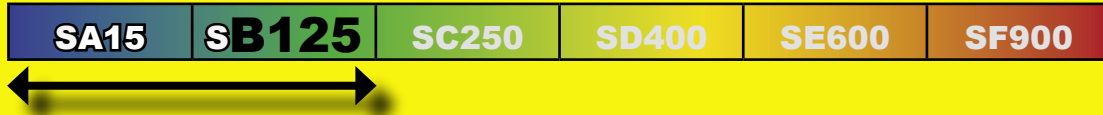

The polyester concrete drainage channel for use around the house

The polyester concrete channels from the **STORA-SELF** range are the ideal solution for surface water drainage around private houses, garage doors, terraces and domestic driveways, due to their low weight and high strength. The channels are available in several widths and in 1m or 0,5m lengths. All channels are level invert and are connected by means of a tongue and groove jointing system. A wide range of overlay gratings is available with the system to suit a variety of applications.



The **STORA-SELF** channels type **SB** are suitable for loadings up to and including class **B125**.



STORA-SELF is available as follows:

STORA-SELF	Width 100	Width 150	Width 200
A15	x	x	x
B125	x	x	x

STORA-DRAIN

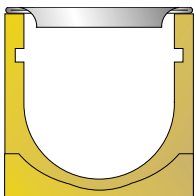

SELF



A15 - B125
SB100 - SB150 - SB200

CHANNELS WITH LEVEL INVERT

TYPE	L (m)	H (mm)	Weight (Kg)	Art.N°	Vertical outlet on channel	Units per pallet
SB100 B=100 D=125	1	110	8,3	S4100111	Ø110	72
	0,5	110	4,0	S4100051	-	-
SB150 B=150 D=190	1	195	20,2	S4300006	Ø160	45
	0,5	195	12,2	S4300007	-	-
SB200 B=200 D=240	1	240	23,7	S4400006	Ø200	35
	0,5	240	16,7	S4400007	-	-

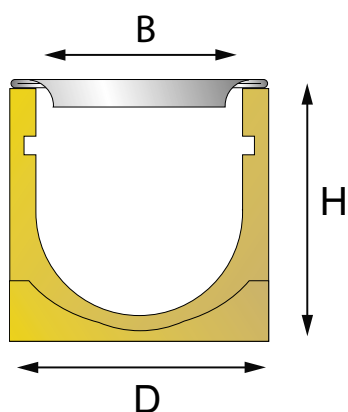

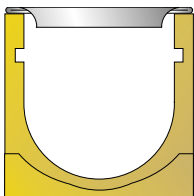

A15 - B125
SB100 - SB150 - SB200

SUMP UNIT

TYPE		L (m)	H (mm)	Weight (Kg)	Art.N°	Outlets
SB100 	Sump unit including galvanised bucket	0,5	285	12,0	S4000002	Ø110
SB150 	Channel with rectangular vertical outlet	1	195	20,6	S4300011	-
	Gully	0,5	350	19,0	S3000153	Ø160
			700	34,1	S3000154	Ø160
	Bucket	-	350	2,8	S7000003	-
600			3,6	S7000004	-	
SB200 	Channel with rectangular vertical outlet	1	240	27,9	S4400011	-
	Gully	0,5	350	19,0	S3000153	Ø160
			700	34,1	S3000154	Ø160
	Bucket	-	350	2,8	S7000003	-
600			3,6	S7000004	-	
Foul-air trap 	Dia.	For sump unit		Weight (Kg)	Art.N°	
	Ø110	SB100		0,1	S7000010	
	Ø110	SB100		1,0	S7000005	
	Ø160	SB150, SB200		3,2	S7000006	
	Ø200	SB200		4,0	S7000007	
Foul-air trap with leaf catcher 	Ø110	Fits on every channel SB100		0,3	S6000003	

STORA-DRAIN

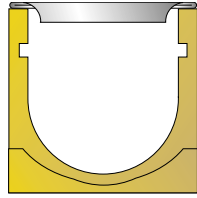

SELF



A15 - B125
SB100 - SB150 - SB200

HOW DO YOU MAKE UP A CHANNEL RUN ?

SB100

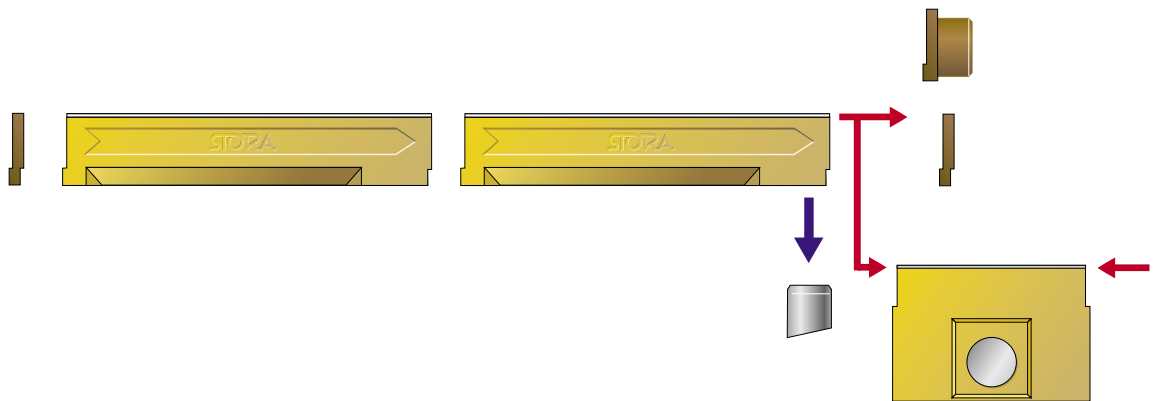

SB150/200

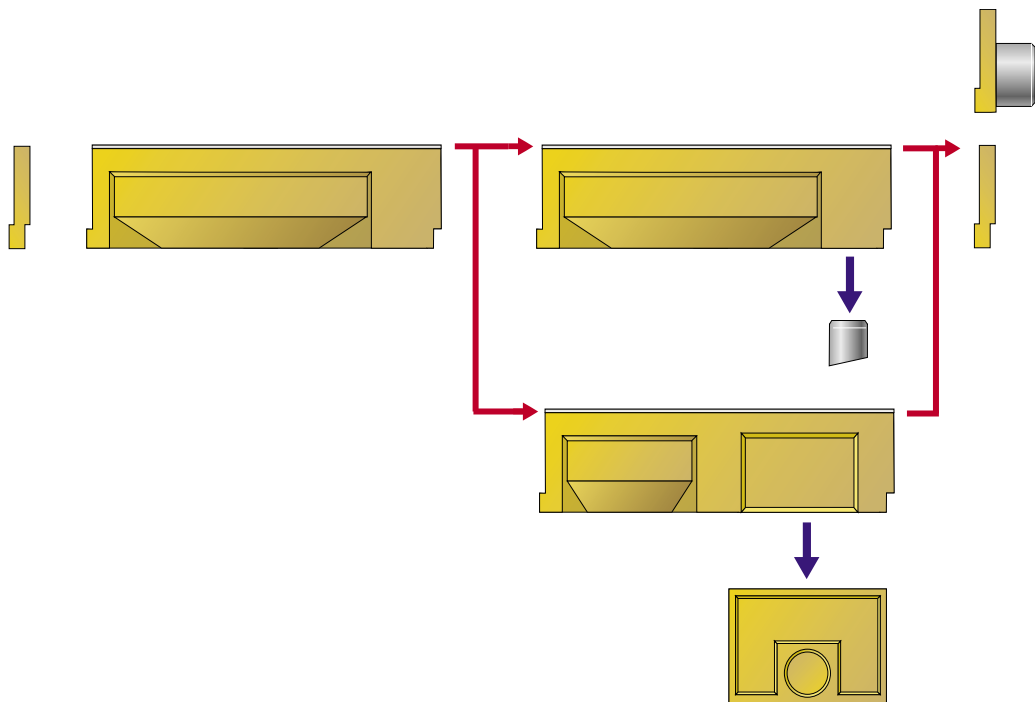

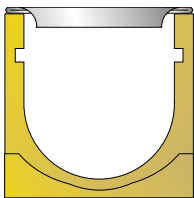

A15 - B125
SB100 - SB150 - SB200

ENDCAPS (with or without outlet)

For channel TYPE	N°	Height (mm)	Weight (Kg)	Art.N°	Integrated Outlet
SB100	-	110	0,1	S4110011*	-
	-	110	0,2	S4210011*	Ø110
SB150	-	195	1,5	S4300002	-
	-	195	1,4	S4300003	Ø110
SB200	-	240	2,4	S4400002	-
	-	240	2,5	S4400003	Ø160

(*)endcap in PE

System SB100: PE

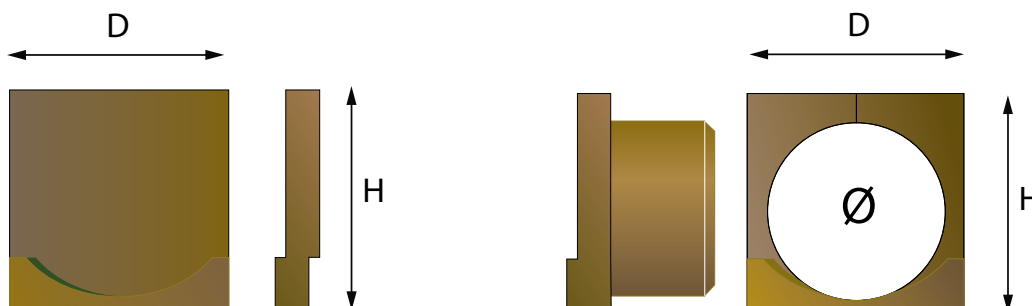

System SB150/200: Polyester concrete

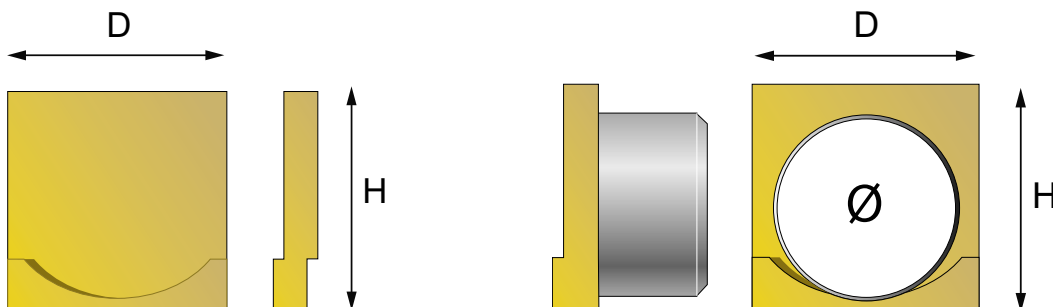

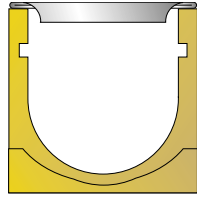

A15 - B125
SB100 - SB150 - SB200

GRATINGS FOR SELF - type SB

(Colour and finishing of the gratings may vary from the images.)

Slotted grating galvanised

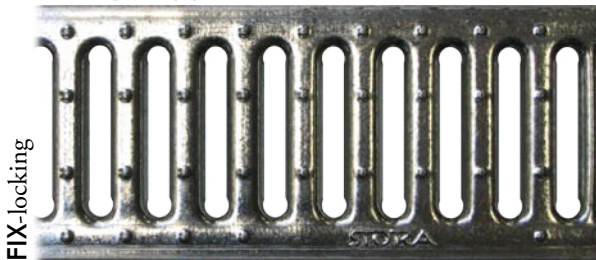

SB100: class A15

Slotted grating galvanised 6mm slot

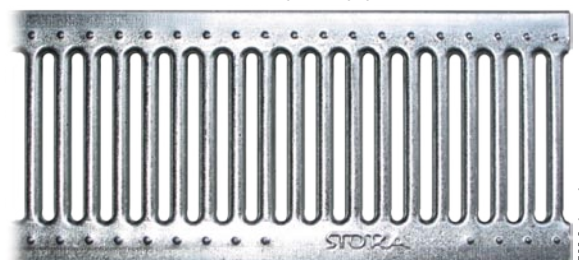

SB100: class A15

Slotted grating galvanised

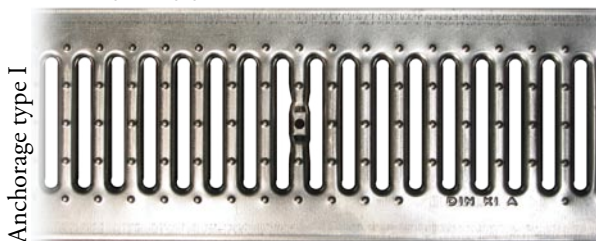

SB150: class A15

Slotted grating stainless steel



SB100: class A15

Slotted grating copper

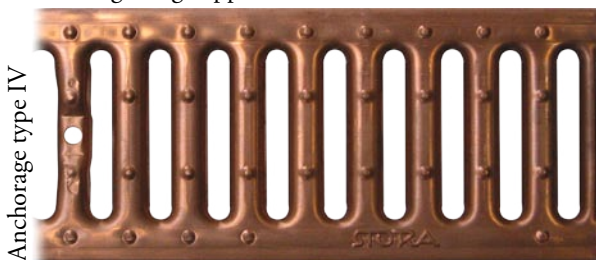

SB100: class A15

Slotted grating ductile iron

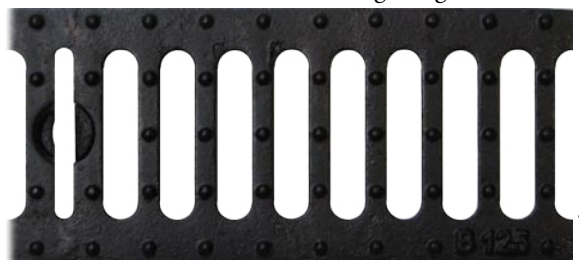

SB100/150/200: class B125

Slotted grating brass

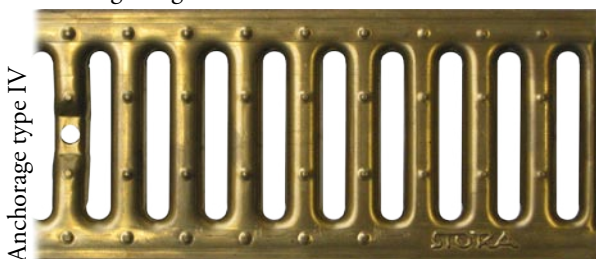

SB100: class A15

Mesh grating galvanised



SB100/150: class B125 - SB200: class A15

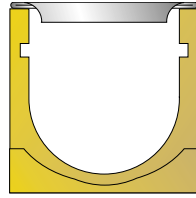

A15 - B125
SB100 - SB150 - SB200

GRATINGS SELF - type SB

For channel TYPE	Grating type	Material	Slot width Mesh size (mm)	Class	Length (m)	Weight (Kg)	Art. N°
SB100	Slotted grating FIX-locking	Galvanised	10	A15	1	1,6	S4211100
					0,5	0,8	S4211050
			6	A15	1	1,5	S4211200
					0,5	0,8	S4211150
	Slotted grating type I-anchorage	Stainless steel	10	A15	1	1,3	S4200105
					0,5	0,6	S4200055
			6	A15	1	1,5	S4200110
					0,5	0,8	S4200115
		Copper	10	A15	1	2,3	S4200106
					0,5	1,1	S4200056
		Brass	10	A15	1	2,2	S4200107
					0,5	1,1	S4200057
		Cast iron - Lay-on 11mm *	17	B125	0,5	2,8	S4200250
					Mesh grating	Galvanised	33x22
0,5	1,5	S4200005					
SB150	Slotted grating	Galvanised	10	A15	1	2,8	S4300103
					0,5	1,4	S4300053
					Cast iron - Lay-on 6mm *	15	B125
	Mesh grating	Galvanised	33x33	B125	1	4,9	S4300004
					0,5	2,4	S4300005
SB200	Slotted grating	Cast iron - Lay-on 6mm *	16	B125	0,5	5,1	S4400008
	Mesh grating	Galvanised	33x33	A15	1	5,8	S4400004
					0,5	2,9	S4400005

(*Please take into account the lay-on thickness of the gratings when installing the channels.



FIX system = integrated locking with 'bumps'

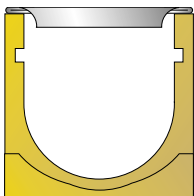

A15 - B125
SB100 - SB150 - SB200

ANCHORAGES

Anchorage type	Material	Anchorage	For channel TYPE	Weight (Kg)	Art. N°
I For slotted grating, mesh grating and cast iron grating	Galvanised	M8x70	SB100	0,1	S5000001
		M8x100	SB150	0,2	S5100001
			SB200	0,3	S5200001
IV For slotted grating in stainless steel, copper and brass	Stainless steel	M8x70	SB100	0,1	S5000006

OVERVIEW LOCKING SYSTEMS

Onlaying grating not anchored

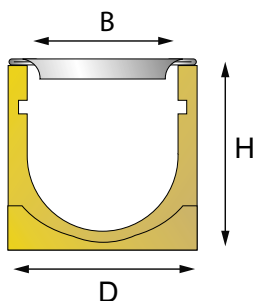

Grating with integrated FIX-locking

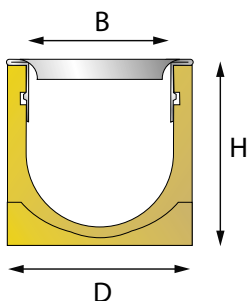

Grating anchored in the channel

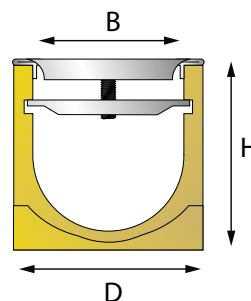

Anchorage type I / IV
galvanised / stainless steel



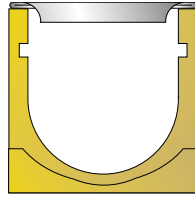

A15 - B125
SB100 - SB150 - SB200

SPECIFICATIONS (BASIC TEXT WITH OPTIONS) SELF - type SB

Width 100

- channel in polyester concrete with level invert
- height of the channels: 110mm

Options STORA-SELF W100:

- sump unit
 - with bucket in galvanised steel
 - with or without foul-air trap (dia. Ø110)
- gratings:
 - slotted grating in:
 - galvanised steel class A15 (with integrated **FIX**-locking) - 10mm slot
 - galvanised steel class A15 (with integrated **FIX**-locking) - 6mm slot
 - stainless steel class A15 - 10mm slot
 - stainless steel class A15 - 6mm slot
 - copper class A15
 - brass class A15
 - ductile iron class B125
 - mesh grating in galvanised steel class B125
- anchorages: "FIX" system or anchorage type I or IV

Width 150 and 200

- channel in polyester concrete with level invert

Options STORA-SELF W150 and W200:

- channel with rectangular vertical outlet and gully width 150, height 350mm or 700mm:
 - with bucket in galvanised steel
 - with or without foul-air trap (dia. Ø160)
- slotted grating in galvanised steel class A15 (width 150)
- mesh grating in galvanised steel class B125 (width 150) and class A15 (width 200)
- ductile iron slotted grating class B125
- anchorage type I

STORA-DRAIN

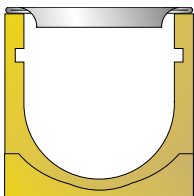

SELF



A15 - B125
SB100 - SB150 - SB200



OTHER PRODUCTS:

STORA-DRAIN RESIDENTIAL-type SCB

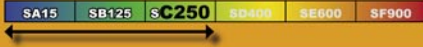

The multi-purpose polyester concrete drainage channel for light applications

Due to their low weight and high strength, the polyester concrete channels with plain polymer edge from the **STORA-RESIDENTIAL** range are the ideal solution for water drainage in areas with low traffic loads. This limited range of 100mm wide channels offers an easy and economical solution for the most diverse applications, thanks to the wide range of gratings available. The inlaying gratings as well as the tongue and groove jointing system simplify the installation of the channel runs.



The **STORA-RESIDENTIAL** channels type SCB meet the requirements of the EN1433 norm and are suitable up to and including class C250 loadings.

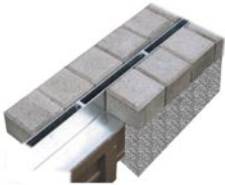

STORA-RESIDENTIAL is available in width 100 with accessories such as endcaps and a sump unit.

DMC-SCB-05-06-EN

STORA-DRAIN TECHNICAL-type SE



The polyester concrete drainage channel with 4mm protective edge profile

Due to their low weight, high strength, good chemical resistance and integrated galvanised or stainless steel protective edge profiles, the polyester concrete channels from the **STORA-TECHNICAL** range are the ideal solution for surface water drainage in areas with medium to heavy traffic loads. The **STORA-TECHNICAL** channel range offers solutions for surface water drainage in areas such as business parks, industrial estates and car parks that require the ability to withstand occasional heavy loadings. The **STORA-TECHNICAL** drainage channels are available 100mm wide with or without built-in fall. The 150mm, 200mm and 300mm wide channels are available in 3 heights each with level invert and can be installed in stepped-fall system.



The low weight of the channels as well as the tongue and groove jointing system simplify the installation. The wide range of inlay gratings available offers flexibility for different situations.

The **STORA-TECHNICAL** channels type SE are suitable for loadings up to and including class E600. The quality of the channels and the matching gratings is guaranteed in accordance with EN1433 by KIWA (KOMO certificate K13348).

STORA-TECHNICAL is available as follows:

STORA-TECHNICAL	Width 100	Width 150	Width 200	Width 300
D400	x	x	x	x
E600	x		x	



DMC-SE-05-06-EN

STORA-DRAIN PARKING-type SC

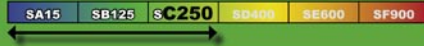

The polyester concrete drainage channel with 2mm protective edge profile

Due to their low weight, high strength, good chemical resistance and integrated galvanised or stainless steel protective edge profiles, the polyester concrete channels from the **STORA-PARKING** range are the ideal solution for surface water drainage in areas with medium traffic loads such as car parks, shopping streets, kerb sides, footpaths, etc..



The **STORA-PARKING** drainage channels are available 100mm wide with or without built-in fall. The 150mm, 200mm and 300mm wide channels are only available in one depth with level invert. The low weight of the channels as well as the tongue and groove jointing system simplify the installation.

The wide range of inlay gratings available offers flexibility for different situations.

The **STORA-PARKING** channels type SC are suitable for loadings up to and including class C250. The quality of the channels and the matching gratings is guaranteed in accordance with EN1433 by KIWA (KOMO certificate K13348).



DMC-SC-05-06-EN

STORA-PARKING is available as follows:

STORA-PARKING	Width 100	Width 150	Width 200	Width 300
A15	x			
B125	x	x		x
C250	x	x	x	x

STORA-DRAIN SUPER-type SF

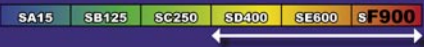

The polyester concrete drainage channel with cast iron protective edge profile

Due to their solid design, high strength, good chemical resistance and integrated ductile iron protective edge profile, the polyester concrete channels from the **STORA-SUPER** range are the ideal solution for surface water drainage in areas with heavy and intensive traffic loads.



The **STORA-SUPER** drainage channels are available 100mm wide with or without built-in fall. The 150mm, 200mm and 300mm wide channels are available in 3 heights each with level invert and can be installed in stepped-fall system. All channels within the **STORA-SUPER** range are delivered complete with gratings in various loadings. Please refer to the table below for availability.

The **STORA-SUPER** type offers a lot of advantages for both installation and maintenance:

- The pre-installed gratings as well as the tongue and groove jointing system simplify the installation.
- The unique bolting system ensures stability and safety, even under the heaviest traffic loads.
- The bolting system also offers user-friendly maintenance as the 100mm, 150mm and 200mm wide **STORA-SUPER** gratings are secured using only one bolt per grating.

The **STORA-SUPER** channels type SE are suitable for loadings up to and including class E900. The quality of the channels and the matching gratings is guaranteed in accordance with EN1433 by KIWA (KOMO certificate K13348).

STORA-SUPER is available as follows:

STORA-SUPER	Width 100	Width 150	Width 200	Width 300
D400	x	x	x	x
E600	x			
E900	x	x	x	x
E900 HM (heelmaster)	x			



DMC-SF-05-06-EN

